

# Miele

HONEYCOMB CARE

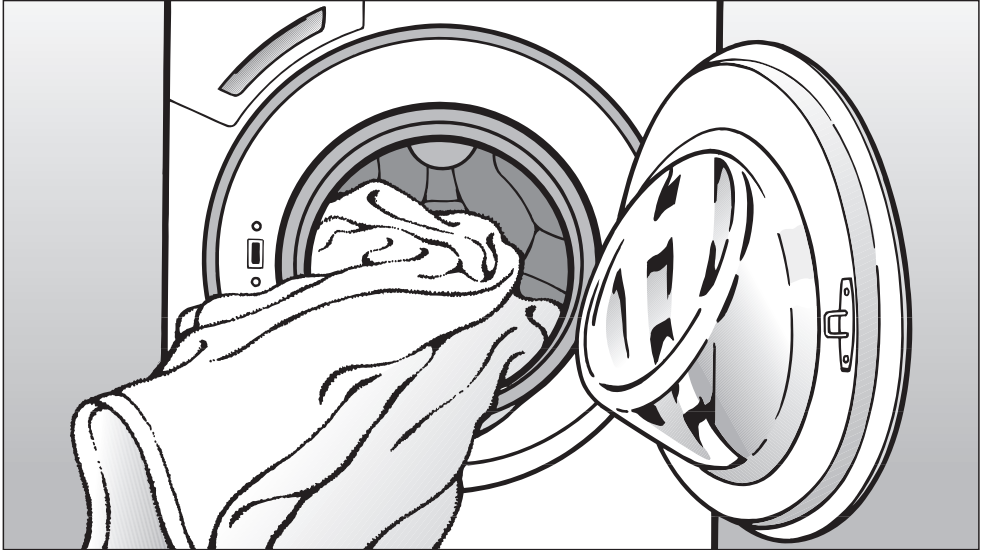

## Operating instructions for Washing machine W 4144 WPS

To avoid the risk of accidents or damage to the machine it is **essential** to read these instructions before it is installed and used for the first time.

en - GB

M.-Nr. 07 170 950

# Caring for our environment

---

## Disposal of the packing material

The transport and protective packing has been selected from materials which are environmentally friendly for disposal and can normally be recycled.

Ensure that any plastic wrappings, bags etc. are disposed of safely and kept out of the reach of babies and young children. Danger of suffocation!

Rather than just throwing these materials away, please ensure they are offered for recycling.

## Disposal of your old appliance or machine

Electrical and electronic appliances / machines often contain materials which, if handled or disposed of incorrectly, could be potentially hazardous to human health and to the environment. They are, however, essential for the correct functioning of your appliance or machine. Please do not therefore dispose of your old machine or appliance with your household waste.

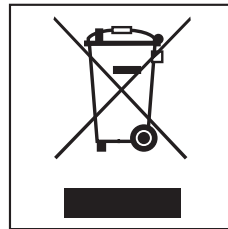

Please dispose of it at your local community waste collection / recycling centre or contact your Dealer for advice. Ensure that it presents no danger to children while being stored for disposal.

It should be unplugged or disconnected from the mains electricity supply by a competent person.

<b>Caring for our environment</b> .....	2
<b>Warning and Safety instructions</b> .....	6
<b>Operating the machine</b> .....	10
Control panel .....	10
<b>Before using for the first time</b> .....	12
<b>Washing environmentally and economically</b> .....	13
Energy and water consumption .....	13
Detergent .....	13
<b>How to wash correctly</b> .....	14
<b>Spinning</b> .....	19
Final spin speed .....	19
Rinse and interim spin .....	19
To omit the final spin (Rinse hold) .....	19
To omit rinse and interim spin and the final spin (No ☺) .....	19
<b>Delay start</b> .....	20
<b>Programme chart</b> .....	21
<b>Programme sequence</b> .....	24
<b>Garment care label symbols</b> .....	26
<b>Changing the programme sequence</b> .....	27
Cancelling a programme .....	27
Interrupting a programme .....	27
Changing a programme .....	27
Adding or removing laundry after a programme has started .....	28
Safety lock .....	28

# Contents

---

<b>Detergent</b> . . . . .	29
The correct detergent . . . . .	29
Water softener . . . . .	30
Washing with several components . . . . .	30
Fabric conditioners and liquid starch . . . . .	31
Automatic dispensing of fabric conditioner or liquid starch to laundry at the end of a programme . . . . .	31
Colour run and dye removers / dyes . . . . .	31
 <b>Cleaning and care</b> . . . . .	 32
External casing and fascia panel . . . . .	32
Extra cleaning . . . . .	32
Cleaning the detergent dispenser drawer . . . . .	32
Descaling the machine . . . . .	33
Cleaning the filter in the water inlet . . . . .	34
 <b>Problem solving guide</b> . . . . .	 35
The programme does not start . . . . .	35
Fault messages in the display . . . . .	36
General problems . . . . .	37
An unsatisfactory wash result . . . . .	38
The drum door does not open when you press the Door button . . . . .	39
Opening the drum door in the event of a blocked drain outlet and/or power failure . . . . .	40
Blocked drain outlet . . . . .	40
 <b>After sales service</b> . . . . .	 42
Future updates (PC) . . . . .	42
Appliance guarantee . . . . .	42
Optional accessories . . . . .	42
 <b>Installation and connection</b> . . . . .	 43
Front view . . . . .	43
Rear view . . . . .	44
Installation surface . . . . .	45
Transporting the machine to its installation site . . . . .	45
Removing the transit fittings . . . . .	45
Re-fitting the transit bars . . . . .	47

Levelling the machine . . . . .	48
Washer-dryer stack. . . . .	49
The Miele Waterproof system . . . . .	50
Connection to the water supply . . . . .	51
Connection to the drainage system. . . . .	53
Electrical connection U.K. . . . .	54
<b>Consumption data</b> . . . . .	<b>55</b>
Notes for test institutes: . . . . .	55
<b>Technical data</b> . . . . .	<b>56</b>
<b>Programmable functions</b> . . . . .	<b>58</b>
To access programmable functions. . . . .	58
To select a programmable function . . . . .	58
To alter a programmable function . . . . .	58
To come out of programmable functions . . . . .	58
Language  . . . . .	58
Water plus . . . . .	59
Gentle action . . . . .	59
Suds cooling . . . . .	59
Code . . . . .	60
Temperature unit . . . . .	61
Buzzer . . . . .	61
Keypad tone . . . . .	61
Brightness . . . . .	61
Contrast . . . . .	61
Standby display . . . . .	62
Memory . . . . .	62
Anti-crease. . . . .	62
<b>Optional accessories</b> . . . . .	<b>63</b>
CareCollection . . . . .	63

# Warning and Safety instructions

---

This washing machine conforms to current safety requirements. Inappropriate use can, however, lead to personal injury and damage to property.

To avoid the risk of accidents and damage to the washing machine, please read these instructions carefully before using it for the first time. They contain important information on its installation, safety, use and maintenance. Keep these instructions in a safe place and ensure that new users are familiar with the content. Pass them on to any future owner.

## Correct application

► This washing machine is for domestic use only and can only be used to wash items which are specified by the manufacturer to be machine-washable on the wash care label, and textiles composed of hand-washable wool or wool blend fabrics as well as satin, lace, silk and other hand-washable garments. Any other applications may be dangerous. Miele cannot be held liable for damage resulting from incorrect or improper use or operation.

► This washing machine is not intended for use by persons (including children) with reduced physical, sensory or mental capabilities, or lack of experience and knowledge, unless they are supervised whilst using it or have been shown how to use it by a person responsible for their safety.

## Safety with children

► Keep children away from the washing machine at all times. It is not a toy! To avoid the risk of injury do not allow children to play on or near it or to play with its controls. Supervise children whilst you are using it.

► Older children may only use the washing machine if its operation has been clearly explained to them and they are able to use it safely, recognising the dangers of misuse.

► For machines with a 'porthole' door, remember that the porthole glass will be hot when washing at very high temperatures. Do not let children touch it.

## Technical safety

► Before setting up the washing machine, check it for any externally visible damage.

Do not install or use a damaged washing machine.

► Before connecting the washing machine, ensure that the connection data on the data plate (voltage and connected load) match the mains electricity supply. If in any doubt, consult a qualified electrician.

► The electrical safety of this washing machine can only be guaranteed when continuity is complete between it and an effective earthing system which complies with current local and national safety regulations. It is most important that this basic safety requirement is present and regularly tested, and where there is any doubt the household wiring system should be inspected by a qualified electrician. The manufacturer cannot be held liable for the consequences of an inadequate earthing system (e.g. electric shock).

► Do not connect the washing machine to the mains electricity supply by an extension lead. Extension leads do not guarantee the required safety of the appliance (e.g. danger of overheating).

► Faulty components must only be replaced by genuine Miele original spare parts. Only when these parts are fitted can the safety standards of the machine be guaranteed.

► Unauthorised repairs could result in unforeseen dangers for the user, for which Miele cannot accept liability. Repairs should only be undertaken by a Miele approved service technician. Ensure current is not supplied to the machine until after maintenance or repair work has been carried out.

► If the connection cable is faulty it must only be replaced by a Miele approved service technician to protect the user from danger.

► In the event of a fault or for cleaning purposes, the washing machine is only completely isolated from the electricity supply when:

- it is switched off at the wall socket and the plug is withdrawn, or
  - it is switched off at the mains, or
  - the mains fuse is withdrawn, or the screw-out fuse is removed (in countries where this is applicable).
- The Miele "Water protection system" protects from water damage provided the following conditions have been met:
- the machine is correctly plumbed in and connected to the electricity supply.
  - if a fault has been identified, the machine must be examined by a competent person before further use, and repaired if necessary.

► In countries where there are areas which may be subject to infestation by cockroaches or other vermin, pay particular attention to keeping the machine and its surroundings in a clean condition at all times. Any damage which may be caused by cockroaches or other vermin will not be covered by the machine guarantee.

## Warning and Safety instructions

---

▶ This washing machine may only be used in mobile installations such as ships if a risk assessment of the installation has been carried out by a suitably qualified engineer.

▶ Do not make any alterations to the washing machine, unless authorised to do so by Miele.

### Correct use

▶ Do not install your washing machine in rooms where temperatures below freezing may occur. Frozen hoses may burst or split. The reliability of the electronic control unit may be impaired at temperatures below freezing point.

▶ Before using the washing machine for the first time, check that the transit bars at the rear of the machine have been removed (see section on "Installation"). During spinning, a transit bar which is still in place may result in damage to both the machine and adjacent furniture or appliances.

▶ Turn off the stopcock if the machine is to be left for any length of time (e.g. holiday), especially if there is no floor drain (gully) in the immediate vicinity.

▶ Flooding danger.

If hooking the drain hose into a wash basin, check that the water can drain off quickly enough to prevent the sink from overflowing. Make sure the drain hose is secure, so that the force of the water flowing out of the hose does not dislodge it.

▶ Take care to ensure that foreign objects (e.g. nails, pins, coins, paper clips) do not find their way into the machine with the laundry. These may damage components of the machine (e.g. suds container, drum), which in turn can result in damage to the laundry.

▶ If the correct amount of detergent is dispensed, the machine should not need to be descaled. If, however, you do wish to descale the machine only use proprietary non-corrosive descaling agents and strictly observe the instructions on the packaging. A special descaling agent is available to order from the Miele Spare Parts Department or via the internet on [www.miele-shop.com](http://www.miele-shop.com).



# Warning and Safety instructions

---

▶ Textiles which have been pre-treated in solvent based cleaning agents must be thoroughly rinsed in clean water before being washed in the machine.

▶ Never use solvent based cleaning agents, e.g. those containing benzene, in this machine, as this may result in damage to component parts and create toxic fumes. Such agents also pose a fire and explosion hazard.

▶ Never use solvent based cleaning agents, e.g. those containing benzene, to clean the outside surfaces of this machine. They can cause damage to plastic surfaces.

▶ Only use dyes specified by the manufacturer as being suitable for use in a domestic washing machine. Always observe the manufacturer's instructions carefully.

▶ Colour run and dye removers contain sulphur compounds which can cause damage such as corrosion. Do not use these products in this machine.

▶ If liquid detergent comes into contact with the eyes, rinse them thoroughly with lukewarm water immediately. If swallowed, seek medical assistance immediately and retain the packaging or label for reference. Those with skin problems or sensitive skin should avoid their skin coming into contact with liquid detergent.

▶ Only remove laundry from the washing machine once the drum has stopped turning. Reaching into a moving drum is extremely dangerous and could result in injury.

## Accessories

▶ Accessory parts may only be fitted when expressly approved by Miele. If other parts are used, guarantee, performance and product liability claims will be invalidated.

Miele cannot be held liable for damage caused by non-compliance with these Warning and Safety instructions.

# Operating the machine

## Control panel

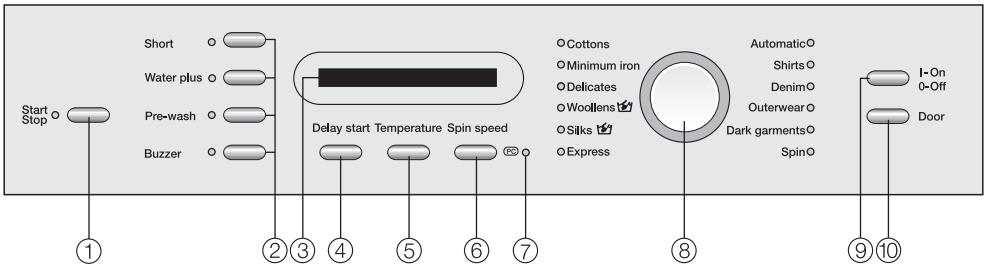

### ① **Start/Stop button**

For starting the programme selected and cancelling a programme once it has started.

### ② **Extra option buttons**

Various extra options can be added to the washing programmes.

### ③ **Display**

See the following page for more information.

### ④ **Delay start button**

For delaying the start time of a programme.

### ⑤ **Temperature button**

For selecting a temperature.

### ⑥ **Spin speed button**

For selecting the final spin speed or *Rinse hold* or *Without spin* .

### ⑦ **PC / Optical interface**

This is used by service technicians to run diagnostic checks on your machine and can also be used to update programming data in the future.

### ⑧ **Programme selector**

For selecting a programme. The indicator light next to the selected programme will come on. The programme selector can be turned clockwise or anti-clockwise.

### ⑨ **I-On/0-Off button**

For switching the machine on or off.

### ⑩ **Door button**

Opens the machine door.

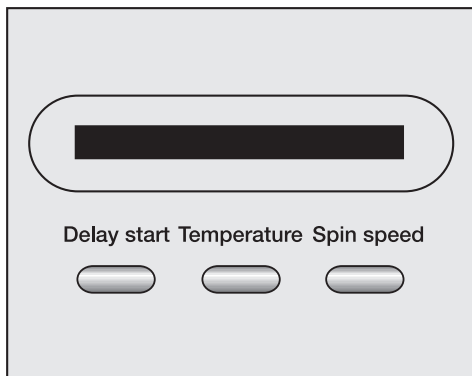

The following are selected via the display:

- wash temperature
- spin speed
- delay start
- cancellation of a programme
- safety lock
- programmable functions

The display also shows:

- the programme duration
- the programme sequence

## Programme duration

After the start of a programme, the estimated programme duration will appear in the display in hours and minutes.

When delay start is being used, the programme duration will appear after the delay start time has elapsed.

During the first 8 minutes the washing machine measures how much water is being absorbed by the laundry and uses this to calculate the load. The programme duration may be longer or shorter depending on this absorbency rate.

## Delay start

The delay start time selected will appear in the display.

After the *Start/Stop* button has been pressed, the delay start time will start counting down. If the delay start time is more than 10 hours, it will count down by the hour. If it is less than 9 hours and 59 minutes it will count down minute by minute.

Once the delay start time has elapsed, the programme begins and the estimated programme duration shows in the display.

## Programmable functions

The programmable functions can be used to tailor washing programmes to suit your individual requirements. In programming mode, the display will show the function selected.

# Before using for the first time

---

Before using the machine for the first time ensure that it is correctly installed and connected. See "Installation and connection". Also check that the drain filter is securely tightened to prevent the risk of water leaks during use.

This washing machine has undergone a thorough functional test in the factory and there will be some residual water in the drum from this process.

For safety reasons, spinning is not possible until the machine has been prepared for using for the first time. To activate the spinning function you must run a wash programme without laundry and without detergent.

Using detergent could result in an excessive build-up of foam.

This also activates the ball valve. The ball valve prevents detergent escaping from the suds container into the sump during a wash programme, thus making maximum use of the detergent.

- Press the *I-On/0-Off* button in.

If the washing machine is being switched on for the first time, the welcome screen will appear.

The welcome screen will appear in the display every time the machine is switched on until a programme lasting longer than 1 hour has been completed.

## Setting the language

You will be asked to select the language you require for the display. It is possible to change the language at any time via the programmable functions.



- If the language shown is not the one you want, select the language you do want by turning the programme selector. Confirm your selection by pressing the *Start/Stop* button.

## Reminder to remove transit bars

To avoid the risk of damage, the transit bars must be removed before the machine is used for the first time. See "Installation and connection" for instructions on how to do this.

- After removing the transit bars (if this has not already been done by your fitter), press the *Start/Stop* button.

## Running your first programme

Run a Cottons 60°C programme without any laundry and without detergent.

- Open the stopcock.
- Press the *Start/Stop* button.
- At the end of the programme switch the machine off.

The machine is now ready for use.

# Washing environmentally and economically

---

## Energy and water consumption

- Water consumption and energy usage are determined by the size of the load.  
To make the most out of your machine, load the maximum dry load for the programme you are using.
- Use the *Automatic* and *Express* programmes for small loads.
- When smaller amounts of laundry are washed using the *Cottons* programme, the automatic load recognition system will reduce the amount of water, time and energy used. This may mean that the time left shown in the display is adjusted during the course of the wash programme.
- Using the *Cottons 60°C* programme, instead of the *Cottons 95°C* programme will give energy savings of between 35% and 45%. This is sufficient for most levels of soiling.

## Detergent

- Do not exceed the amounts of detergent recommended by the manufacturer on the packaging.
- Adjust the dosage to the degree of soiling of the laundry.
- Reduce the amount of detergent with smaller loads (approx.  $\frac{1}{3}$  less than the amount recommended can be used when washing a half load).

## Choosing the correct extra option (Short and Pre-wash)

Select:

- A wash programme together with the *Short* extra option for light to normal soiling where there are no obvious marks.
- A wash programme without any extra options for normal to heavy soiling with visible staining.
- The *Pre-wash* extra option for laundry with large amounts of dirt (e.g. dust, sand).

## When drying with a tumble dryer

Selecting the highest possible spin speed for the wash programme will save energy when drying in a tumble dryer afterwards.

# How to wash correctly

## Brief instructions

The headings numbered ①, ②, ③, . . . show the operating sequence and can be used as brief instructions.

### ① Sort the laundry

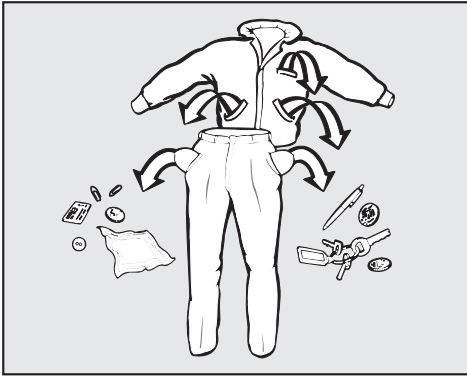

- Empty all pockets.

⚠ Foreign objects (e.g. nails, coins, paper clips, etc.) can cause damage to garments and components in the machine.

- Badly soiled areas, stains etc. should be cleaned as soon as possible, preferably whilst still fresh. Spillages should be carefully dabbed off using a soft colourfast cloth. Do not rub!

Badly soiled areas can be pre-treated with liquid detergent, stain removers etc. first, following the manufacturer's instructions. With particularly stubborn stains ask your dry cleaner for advice.

⚠ If you use a solvent-based cleaning agent (e.g. one containing benzene) to pre-treat a stain, make sure that any plastic parts (e.g. buttons) are protected, and that the cleaning agent is rinsed off before washing the garment in the machine.

⚠ Do not use solvent-based cleaning agents in this machine.

- Sort the laundry by colour and by care label. Most garments have a textile care label in the collar or side seam.

Dark textiles often contain excess dye and should be washed separately several times before being included in a mixed load. Always wash whites and coloureds separately.

- Curtains: Remove lead weights first or place in a laundry bag.
- Underwiring and collar stiffeners: Any loose wiring in bras, shirt collar stiffeners, etc. should be removed or sewn in.
- Knitted garments, trousers and jeans, T-shirts and sweat shirts: Turn inside out, if recommended by the manufacturer.
- Close any zips, fasten hooks and eyes etc before washing.
- Fasten duvet covers etc. to prevent small items from being rolled up inside them.

Do not wash any items in this machine which are specified by the manufacturer as **not washable** on the care label. (☒ symbol)

# How to wash correctly

## 2 Switch on the washing machine

### 3 Load the drum

- Press the *Door* button to open the drum door.
- Unfold the laundry and load loosely in the drum. Mixing both large and small items gives better wash results and also helps distribute the load evenly during spinning.

The most efficient use of energy and water is achieved when a full load is washed. However, do not overload as this causes creases and reduces cleaning efficiency.

Make sure that no garments are caught between the drum door and seal.

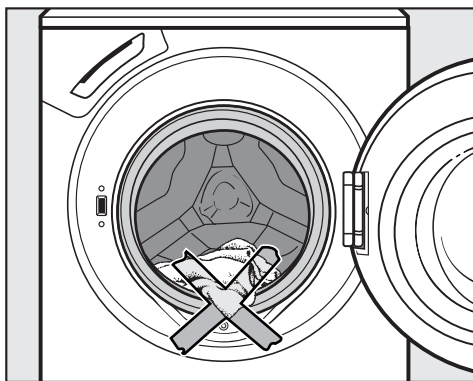

- Shut the door with a gentle swing.

## 4 Select a programme

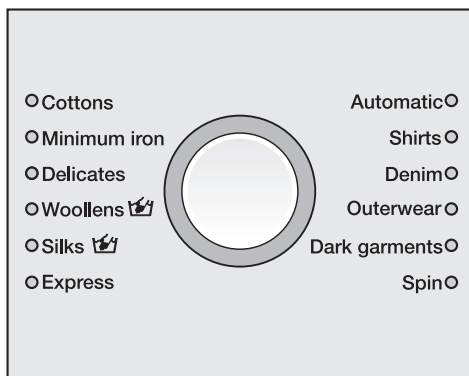

- Turn the programme selector clockwise or anti-clockwise to the required programme. The programme indicator light for the programme selected will come on.

## 5 Select a temperature / spin speed

The suggested temperature and/or spin speed can be changed.

1:49 60° 1400

- Press the *Temperature* button to alter the temperature and press the *Spin speed* button to alter the spin speed.

# How to wash correctly

---

## ⑥ Select an extra option(s)

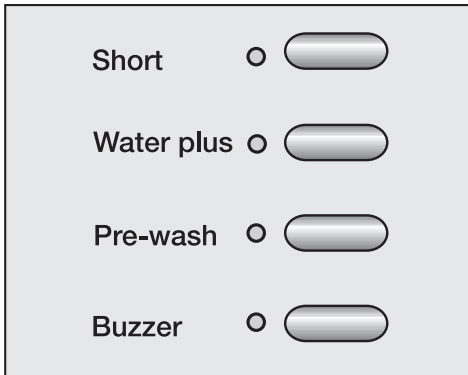

- Select any extra options by pressing the appropriate button. The relevant indicator light will come on to show which extra option has been selected.

Not all the extra options are suitable for use with every programme.

You can only select extra options which are compatible with the basic programme being used.

### Short

For light to normal soiling with no visible staining.

The duration of the main wash is reduced.

### Water plus

The water level in the main wash and the rinses will be increased if the *Water plus* option is selected.

However, you can select other settings for *Water plus*. These are described in "Programmable functions".

### Pre-wash

For laundry with large amounts of dirt e.g. dust, sand.

### Buzzer

An audible tone sounds repeatedly at the end of a programme and when Rinse hold is reached. The buzzer will sound repeatedly until the machine is switched off. The volume of the buzzer can be changed, see "Programmable functions".

## ⑦ Select Delay start (if required)

The start of a programme can be delayed from 30 minutes up to 24 hours, allowing you to make use of night-time economy electricity rates, for example.

See "Delay start" for more information.



## How to wash correctly

### 8 Add detergent

It is important to dispense the correct amount, because . . .

. . . too little detergent results in:

- Laundry not getting properly clean and with time it may become grey and hard to the touch.
- Greasy particles clinging to the laundry.
- Limescale deposits on the heater elements.

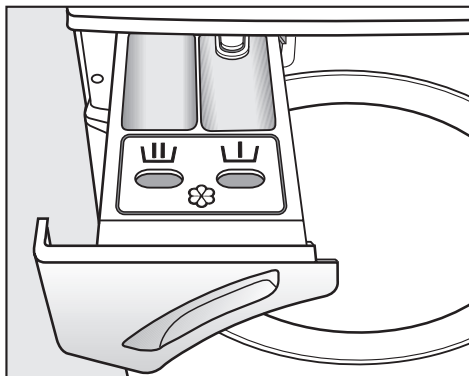

. . . too much detergent results in:

- Excessive foam which causes a low level of agitation and poor wash, rinse and spin results.
- Higher water consumption (an additional rinse cycle will automatically switch in).
- A burden to the environment.



- Pull out the detergent drawer and place detergent in the compartments as follows:



Detergent for the pre-wash (divide the total recommended amount as follows: add  $\frac{1}{3}$  to compartment  and  $\frac{2}{3}$  to compartment )



Detergent for the main wash



Fabric conditioner or liquid starch

- Close the detergent drawer.

See "Detergent" for further information.

# How to wash correctly

## 9 Start the programme

- Press the flashing *Start/Stop* button.

If a delay start time has been selected, then this will count down in the display. At the end of the delay start time or immediately after the programme has started (if no delay start time has been selected) the estimated programme duration will appear in the display. During the first 8 minutes the machine measures how much water is being absorbed by the laundry. The programme duration may be longer or shorter depending on this absorbency rate.

The programme sequence is also shown in the display. The washing machine shows you when each section of the programme is reached.

### Remove the laundry when the programme has finished

In the anti-crease phase after the programme has finished, the following will appear alternately in the display:

0:00 Anti-crease

and

0:00 inish

- Press the *Door* button to open the drum door.
- Remove the laundry.

Check that all items have been removed from the drum. Items left in the drum could discolour other items in the next wash or become discoloured themselves.

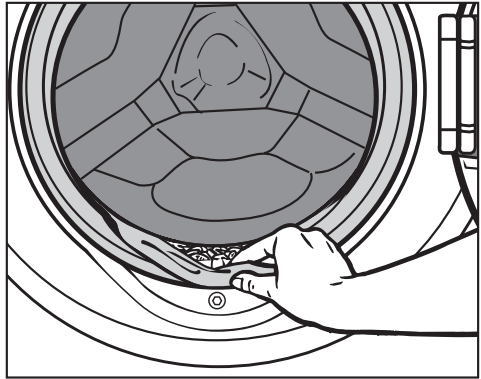

- Check the folds in the door seal for any small articles, e.g. buttons, which might be lodged there.
- Switch the machine off with the *I-On/O-Off* button.
- Close the drum door. Otherwise there is the danger of objects being placed inadvertently in the drum. If these remained unnoticed and were washed in the next load, they could damage the laundry.

## Final spin speed

Programme	rpm
Cottons	1400
Minimum iron	1200
Delicates	600
Woollens	1200
Silks	400
Express	1400
Automatic	1200
Shirts	600
Denim	900
Outerwear	800
Dark garments	1200
Spin	1400

You can reduce the final spin speed. However, you cannot select a final spin speed higher than that shown in the chart above.

## Rinse and interim spin

There is a spin after the main wash and between the rinses. A reduction in the final spin speed will also reduce the interim spin speed. If a spin speed of less than 700 rpm is selected for a *Cottons* programme, an additional rinse is introduced.

## To omit the final spin (Rinse hold)

■ Select the  setting using the *Spin speed* button. The laundry will not be spun and will remain suspended in the final rinse water. This reduces creasing if the laundry is not going to be removed from the drum immediately after the end of the programme.

– To start the final spin:

The washing machine will display the maximum spin speed possible. You can select a spin speed lower than this. Start the final spin by pressing the *Start/Stop* button.

– To end the programme:

Press the *Door* button. The water will drain away. Press the *Door* button again to open the door.

## To omit rinse and interim spin and the final spin (No ©)

■ Select the *No ©* setting using the *Spin speed* button. The laundry is not spun after the final rinse. The water will drain away and the machine will go straight into the anti-crease stage. An additional rinse is introduced if this setting is selected with the *Cottons*, *Minimum iron*, *Express* and *Automatic* programmes.

# Delay start

---

Delay start allows you to choose when you want the programme to start. The start of a programme can be delayed from 30 minutes up to a maximum of 24 hours, allowing you to make use of night-time economy electricity rates, for example.

## Selecting delay start

- Press the *Delay start* button. The following will appear in the display:



- Each press on the *Delay start* button increases the delay start time:
  - in 30 minute steps up to 10 hours,
  - in 1 hour steps from 10 hours upwards.

If you keep the *Delay start* button pressed in, the time will continue to count up to 24 hours.

## Activating delay start

- Press the *Start/Stop* button to activate delay start. The following will appear in the display:



After the delay start time has elapsed, the washing programme will start and the estimated programme duration and the programme sequence will show in the display.

## Altering delay start























You can change the delay start time at any time by pressing the *Delay start* button.

## Cancelling delay start before delay start has been activated









- Press the *Delay start* button until 24 h appears in the display. Then press the *Delay start* button again briefly to cancel delay start.

If you cancel delay start after the delay start time has started counting down, the washing programme will start immediately.

## Programme chart

<b>Cottons</b>       *		<b>30°C to 95°C</b>	<b>Max. load 6.0 kg</b>
Fabric	Cottons, linens or cotton mix fabrics, e.g. table linen, towelling, underwear, T-shirts etc.		
Extra options	Short, Water plus, Pre-wash		
<b>Note for test institutes:</b> Short programme: 3.0 kg load and <i>Short</i> extra option			
<b>Minimum iron</b>         *		<b>30°C to 60°C</b>	<b>Max. load 3.0 kg</b>
Fabric	Synthetics, mixed fibres and easy care cottons. If fabrics have a high proportion of man-made fibres it is advisable to programme the machine for "Gentle action". See "Programmable functions".		
Note	Reduce the spin speed for fabrics which crease easily.		
Extra options	Short, Water plus, Pre-wash		
<b>Delicates</b>       *		<b>cold to 60°C</b>	<b>Max. load 2.0 kg</b>
Fabric	For delicate garments made of synthetic fibres, mixed fibres, rayon and easy care cottons. Curtains, including net curtains, specified as machine-washable by the manufacturer.		
Notes	<ul style="list-style-type: none"> <li>- Dust in curtains usually makes using a programme with pre-wash advisable.</li> <li>- For curtains which crease easily, reduce the spin speed or deselect the spin.</li> </ul>		
Extra options	Short, Pre-wash		
<b>Woollens</b>    *		<b>cold to 40°C</b>	<b>Max. load 2.0 kg</b>
Fabric	Machine-washable or hand-washable wool or wool blend fabrics. If the care label does not specify a temperature, wash using the cold setting.		

## Programme chart























<b>Silks</b>   *		<b>cold to 30°C</b>	<b>Max. load 1.0 kg</b>
Fabric	Silks and other handwashable fabrics with no wool content, e.g. satin, lace and silk.		
Note	Place tights, bras etc. in a washing bag.		
Extra option	Water plus		
<b>Express</b>   *		<b>cold to 40°C</b>	<b>Max. load 3.0 kg</b>
Fabric	Small loads of items which require freshening up and which can be washed in a <i>Cottons</i> programme.		
Note	This programme can be used for rinsing individual items. Select the <i>cold</i> setting, and do not add any detergent.		
Extra option	Water plus		
<b>Automatic</b>     *		<b>cold to 40°C</b>	<b>Max. load 3.5 kg</b>
Fabric	Mixed loads of garments suitable for the <i>Cottons</i> and <i>Minimum iron</i> programmes. Sort according to colour.		
Note	The wash parameters (e.g. water level, wash rhythm and spin speed) are adjusted automatically in this programme to ensure the best possible care and wash result for each item.		
<b>Shirts</b>		<b>cold to 60°C</b>	<b>Max. load 2.0 kg</b>
Notes	<ul style="list-style-type: none"> <li>– Pre-treat collars and cuffs if necessary.</li> <li>– Wash silk garments in the <i>Silks</i> programme.</li> </ul>		
Extra options	Short, Water plus		
<b>Denim</b>		<b>cold to 60°C</b>	<b>Max. load 3.0 kg</b>
Notes	<ul style="list-style-type: none"> <li>– Wash denim inside out.</li> <li>– Denim often contains excess dye and will run during the first few washes. Wash light and dark coloured items separately.</li> </ul>		
Extra options	Short, Pre-wash		



## Programme chart

<b>Outerwear</b>		<b>cold to 40°C</b>	<b>Max. load 2.0 kg</b>
Garment	Outerwear made from micro-fibres such as Gore-Tex <sup>®</sup> , SYMPATEX <sup>®</sup> , WINDSTOPPER <sup>®</sup> etc.		
Notes	<ul style="list-style-type: none"> <li>– Zip up jackets before washing.</li> <li>– Do not use fabric conditioner.</li> </ul>		
Extra options	Short, Water plus, Pre-wash		
<b>Dark garments</b>		<b>cold to 40°C</b>	<b>Max. load 3.0 kg</b>
Item	Black and dark garments made from cotton or mixed fibres.		
Note	Wash inside out.		
Extra option	Short		
<b>Spin</b>			
Notes	<ul style="list-style-type: none"> <li>– Drain only: Select <i>No</i> ☉.</li> <li>– Make sure you select the appropriate spin speed.</li> </ul>		

\* Please note that the "buckets" represent garment care label symbols. See "Garment care label symbols".

# Programme sequence

	Main wash		Rinses		Spinning	
	Water level	Wash rhythm	Water level	Rinses	Interim spin	Final spin
Cottons		Ⓐ		2-4 <sup>1)</sup>	✓	✓
Minimum iron		Ⓒ		2-3 <sup>2)</sup>	✓	✓
Delicates		Ⓓ		3	–	✓
Woollens		Ⓔ		2	✓	✓
Silks		Ⓔ		2	–	✓
Express		Ⓑ		2-3 <sup>2)</sup>	✓	✓
Automatic		ⒶⒷⒸ		2-3 <sup>2)</sup>	✓	✓
Shirts		Ⓒ		2	–	✓
Denim		Ⓒ		3	–	✓
Outerwear		Ⓓ		3	✓ <sup>3)</sup>	✓
Dark garments		Ⓑ		3	✓	✓
Spin	–	–	–	–	–	✓

 = Low water level  
 = Medium water level  
 = High water level

Ⓐ = Intensive rhythm  
 Ⓑ = Normal rhythm  
 Ⓒ = Gentle rhythm  
 Ⓓ = Sensitive rhythm  
 Ⓔ = Handwash rhythm

See the following page for more information about the programme sequences.



This machine has fully electronic controls with automatic load recognition. It takes in the right amount of water required for the programme depending on the amount of laundry and its absorbency rate. This means that programme cycles and durations can vary.

The programme sequences outlined in the chart are based on the basic programme with a full load. Extra options which can be selected have not been taken into account.

The display shows the stage the programme has reached.

### Special features in the programme sequences:

#### Anti-crease:

At the end of every programme, with the exception of the *Woolens* programme, the drum continues to turn at intervals for up to 30 minutes to help prevent creasing. The door can be opened and laundry removed at any time during the anti-crease phase.

- 1) A second rinse is carried out when a temperature of 60°C to 95°C has been selected. A third rinse is carried out when a temperature below 60°C is selected.

#### A third/fourth rinse is carried out if:





- there is too much foam in the drum
- a spin speed lower than 700 rpm has been selected
- No ☺ has been selected



- 2) A third rinse takes place automatically if:





No ☺ has been selected





- 3) In the *Outerwear* programme, laundry is only spun after the main wash.



# Garment care label symbols

Washing	
The figure quoted in the bucket is the maximum temperature the garment can be washed at. The number of bars under the symbol indicates the level of agitation permitted.	
	No bar under the symbol: = normal agitation
	One bar under the symbol: = reduced agitation
	Two bars under the symbol: = much reduced agitation
	Hand wash (if no temperature is specified use the lowest temperature or cold)
	Do not wash

Drying	
The number of dots indicates the drying temperature	
	Normal temperature
	Low temperature
	Do not tumble dry

Ironing	
The number of dots indicates the ironing temperature	
	Hot iron (max sole plate temp. approx. 200°C)
	Medium hot iron (max sole plate temp. approx. 150°C)
	Cool iron (max sole plate temp. approx. 110°C). Do not steam iron garments carrying this symbol.
	Do not iron

Professional cleaning	
	Dry clean only. The letters indicate the type of cleaning agent required.
	
	Professional Wet Clean only
	Do not dry clean

Bleaching	
	Any oxidising bleaching agent can be used
	Only use an oxygen based bleach or a non-chlorine bleach
	Do not bleach

# Changing the programme sequence

---

## Cancelling a programme

You can cancel a programme at any time after it has started.

- Press the *Start/Stop* button.

### Cancel programme

- Press the flashing *Start/Stop* button again.

The suds will be pumped away.

If you want to remove the laundry:

- Press the *Door* button.

If you want to select a different programme:

- Switch the machine off with the *I-On/0-Off* button.
- Switch the washing machine back on again.
- Check that there is still detergent in the detergent drawer. Add detergent, if necessary.
- Select and start a new programme.

## Interrupting a programme

- Switch the machine off with the *I-On/0-Off* button.

To continue with the same programme:

- Switch the machine back on with the *I-On/0-Off* button.

## Changing a programme

After the start of a programme it is no longer possible to select a different programme.

### Temperature

It is possible to select a different temperature up to 5 minutes after the programme has started.

- Press the *Temperature* button.

### Spin speed

It is possible to change the spin speed up until the final spin begins.

- Press the *Spin speed* button.

### Extra options

It is possible to select or deselect the *Short* and *Water plus* extra options up to five minutes after the programme has started.

A programme cannot be cancelled or changed if the safety lock has been activated.

# Changing the programme sequence

## Adding or removing laundry after a programme has started

- Press the *Door* button to open the drum door.
- Add or remove items.
- Close the drum door.

The programme will continue automatically.

### Please note:

Once a programme has started the machine cannot recognise any adjustment to the load.

For this reason, if laundry is added or removed after the start of a programme, the machine will always complete the programme cycle assuming a full load which can lead to an increase in the programme duration shown in the display.

### The door cannot be opened, if:

- the suds temperature is above **55°C**.
- the water is above a certain level.
- the programme has reached the *Final spin* stage.

If you press the *Door* button when the above conditions are present, the following will appear in the display:

 Door locked

## Safety lock

The safety lock prevents the machine from being opened, the programme from being cancelled or the machine from being switched off during a wash programme.

### To activate the safety lock

- Press and hold in the *Start/Stop* button after the programme has started.

Stop or in 3 secs 

- Keep the *Start/Stop* button pressed in until the time has elapsed and the following appears in the display:

Locked 

The safety lock is now activated. It is deactivated automatically at the end of the programme.

### To deactivate the safety lock

- Press and hold in the *Start/Stop* button after the programme has started.

Unlock in 3 secs 



- Keep the *Start/Stop* button pressed in until the time has elapsed and the following appears in the display:

Unlocked 

## The correct detergent

All modern detergents produced for automatic washing machines are suitable. Use dispensing aids, e.g. balls, if these are supplied with the detergent. Tablets are suitable for full loads, but note that it may be impractical to reduce tablets for smaller loads. Some tablets do not dissolve as rapidly as others, and may not be suitable for programmes with short durations. Do not use biological detergents on silk, as the enzymes may damage the silk. Instructions for use and recommended dosage amounts are given on the detergent packaging.

Liquid detergent should be dispensed using a ball provided by the manufacturer for programmes without a pre-wash.

For programmes with a pre-wash you will need to purchase a special container from the Miele Spare Parts department which sits in the main wash compartment  of the detergent dispenser drawer. Add liquid detergent to this container for the main wash and to compartment  for the pre-wash.

	<b>All purpose detergent for whites*</b>	<b>Detergent for coloured fabrics*</b>	<b>Detergent for delicates</b>
Cottons	X	X	
Minimum iron	X	X	
Delicates			X
Woollens	Liquid detergent for machine-washable woollens		
Silks	Liquid detergent for machine-washable silk and woollens		
Express	X	X	
Automatic	X	X	
Shirts	X	X	
Denim		X <sup>1)</sup>	
Outerwear			X
Dark garments		X <sup>1)</sup>	

1) Only use liquid detergent

\* Powder detergent, tablet detergent, liquid detergent and liquid tab detergent

# Detergent

---

## The right amount to dispense will depend on the following:

- The quantity of laundry
- The soiling level of the laundry
  - Lightly soiled  
No visible dirt or stains. Possibly slight body odour.
  - Normally soiled  
Visibly dirty and/or just a few slight stains.
  - Heavily soiled  
Visible dirt and stains and/or dried on soiling.
- The water hardness level.  
Check with your local water supplier if you do not know the hardness level in your area.

## Water softener

A water softener can be used to cut down on the use of detergents in hard water areas. Dispense according to the amount specified on the packaging. First add detergent and then the water softener.

Miele branded water softening tablets are available from the Miele Spare Parts Department or via the internet on [www.miele-shop.com](http://www.miele-shop.com).

Use a quantity of detergent as for soft water.

Miele do not recommend connecting the machine to a household water softener.

## Washing with several components

If you wash using several components (e.g. special application detergents), we recommend always dispensing the agents into compartment  in the following order:

1. Detergent
2. Water softeners
3. Stain remover

This way the agents are distributed more evenly.

## Fabric conditioners and liquid starch

### Fabric conditioners

make garments soft to handle and help prevent static cling when tumble drying.

### Starch

stiffens and gives body to items of laundry, e.g. shirts, tablecloths and bed linen.

### Automatic dispensing of fabric conditioner or liquid starch to laundry at the end of a programme

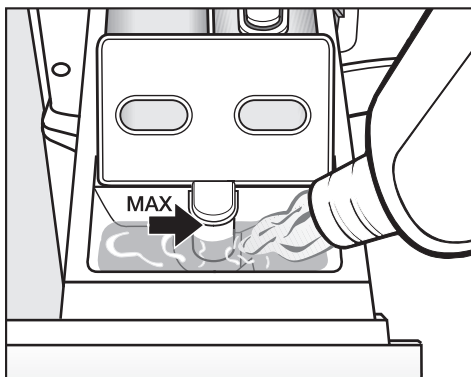

- Add the fabric conditioner or liquid starch to compartment ☼. **Do not exceed the maximum level mark.**

It will be automatically dispensed in the last rinse. At the end of the programme a small amount of water remains in the fabric conditioner compartment ☼.

If starching frequently, thoroughly clean the dispenser compartment, especially the siphon tube and the fabric conditioner channel, regularly. See "Cleaning the detergent dispenser drawer". Do not use powder starch formulations or viscous liquid starch in the ☼ compartment as it will clog up.

## Colour run and dye removers / dyes

- Do not use colour run or dye removers in this machine.
- Dyes suitable for use in domestic washing machines can be used. However, please note that the salt used in the dyeing process can cause corrosion to stainless steel components in the machine if you dye frequently. Always observe the manufacturer's instructions carefully.

## Cleaning and care

 Disconnect the machine from the mains electricity supply and withdraw the plug from the socket before cleaning the machine.

 The washing machine must not be hosed down.

A range of Miele branded cleaning and conditioning products are available to order from your Dealer, the Miele Spare Parts Department or via the internet on [www.miele-shop.com](http://www.miele-shop.com).

### External casing and fascia panel

- Clean the casing with a mild non-abrasive cleaning agent or soap and water using a well wrung-out cloth. Wipe dry with a soft cloth.
- The drum can be cleaned using a suitable proprietary stainless-steel cleaning agent following the manufacturer's instructions on the packaging.

 Do not use solvents, abrasive cleaners, glass cleaners or all-purpose cleaning agents. These might damage plastic surfaces and other components because of the chemicals they contain.

### Extra cleaning

Carry out a hot wash (70°C or above) with powder detergent approx. every 6 weeks to help prevent deposits building up in the machine. These can occur when washing is mainly done at low temperatures, and also lead to unpleasant smells. If you have no reason to wash occasionally at this high temperature, then run a Cottons 95°C programme with detergent but no laundry at regular intervals.

### Cleaning the detergent dispenser drawer

Remove detergent residues regularly.

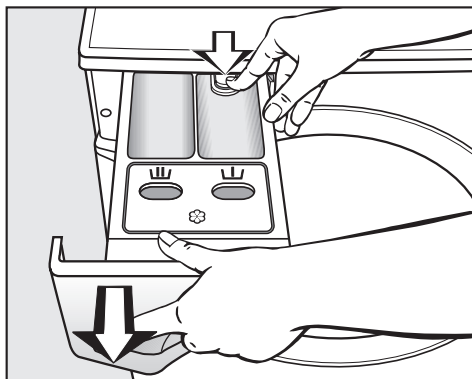

- Pull out the detergent dispenser drawer until a resistance is felt. Press down the release catch and at the same time pull the drawer right out of the machine.
- Clean the detergent drawer with warm water.



## Cleaning the siphon and conditioner channel

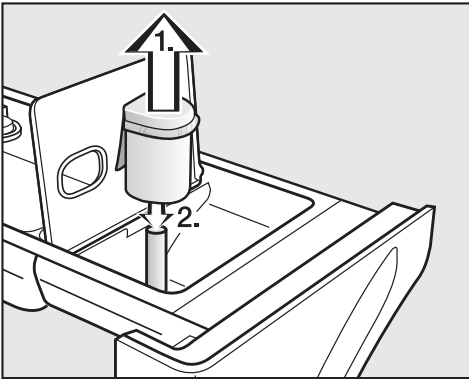

1. Remove the siphon from compartment  and rinse under warm running water. Clean the siphon tube in the same way.
2. Replace the siphon.

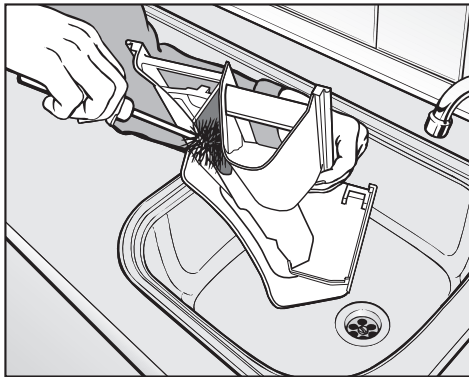

- Clean the fabric conditioner channel using a brush and warm water.

If starching frequently, thoroughly clean the siphon, the siphon tube and the fabric conditioner channel regularly. A build-up of starch will cause them to get clogged.

## Cleaning the detergent dispenser drawer housing

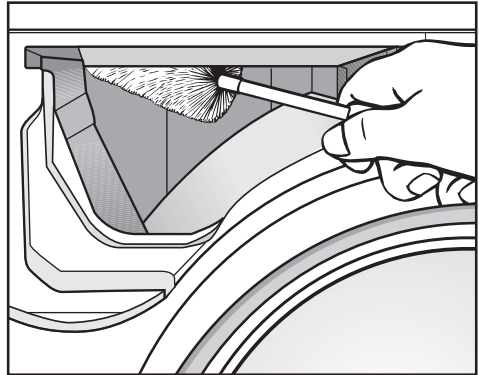

- Use a bottle brush to remove detergent residues and limescale from the jets inside the detergent dispenser drawer housing.

## Descaling the machine

If the correct amount of detergent is dispensed, the machine should not need to be descaled. If, however, you do wish to descale the machine only use proprietary non-corrosive descaling agents and strictly observe the instructions on the packaging.

## Cleaning and care

### Cleaning the filter in the water inlet

The washing machine has a filter to protect the water inlet valve.

The accessible filter in the union in the open end of the inlet hose should be checked every six months, or more often if there are frequent interruptions to the external water supply.

- First turn off the stopcock.
- Unscrew the threaded union connecting the free end of the inlet hose to the stopcock.

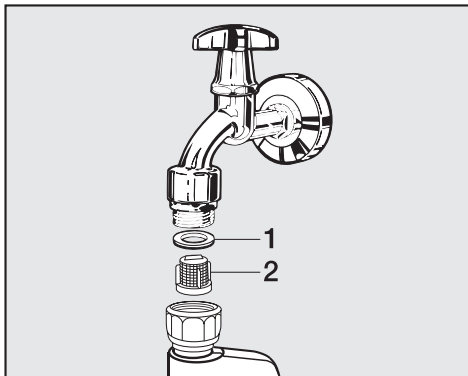

- Remove the rubber seal **1** from the recess.
- Using pointed pliers, take hold of the plastic filter bar **2** and remove.
- Clean the plastic filter.
- Put the filter and seal back in the reverse order and reconnect the hose.

Turn on the stopcock and check the connection is watertight. If water drips out, tighten the connection.

**Never** forget to put the filter back in place after cleaning.

## Problem solving guide





With the help of the following notes, minor faults in the performance of the machine, some of which may result from incorrect operation, can be put right without contacting the Service Department.

 Repair work to electrical appliances should only be carried out by a suitably qualified person in strict accordance with current local and national safety regulations. Repairs and other work by unqualified persons could be dangerous. The manufacturer cannot be held liable for unauthorised work.

### The programme does not start

Problem	Possible cause	Remedy
<b>The display remains dark, and the <i>Start/Stop</i> button indicator light does not come on.</b>	There is no power to the machine.	Check whether <ul style="list-style-type: none"><li>– the mains plug is plugged in and switched on.</li><li>– the fuse or circuit breaker has tripped.</li></ul>
<b>You are asked to enter a code.</b>	Access via a code has been activated.	Enter the code and confirm the entry. Deactivate the code if you do not wish this message to appear in the display the next time the machine is switched on.
<b>The display is dark.</b>	The display has switched off automatically to save energy (Standby mode).	Press a button. Standby comes to an end.

## Problem solving guide

<b>Fault messages in the display</b>		
<b>Problem</b>	<b>Possible cause</b>	<b>Remedy ①</b>
 <b>lights up in the display and Drain fault flashes.</b>	<ul style="list-style-type: none"> <li>– The water outlet is blocked or restricted.</li> <li>– The drain hose has been fixed too high.</li> </ul>	<ul style="list-style-type: none"> <li>– Clean the drain filter and the drain pump.</li> <li>– The maximum delivery head is 1 m.</li> </ul>
 <b>lights up in the display and Water inlet fault flashes.</b>	<ul style="list-style-type: none"> <li>– The water inlet is blocked or restricted.</li> </ul>	Check whether <ul style="list-style-type: none"> <li>– the stopcock is opened properly.</li> <li>– the inlet hose is kinked.</li> <li>– the water pressure is too low.</li> </ul>
 <b>lights up in the display and Waterproof fault flashes.</b>	The water protection system has reacted.	Call the Service Department.
 <b>lights up in the display and Technical fault flashes.</b>	There is a fault.	Start the programme again. If the fault message appears again, contact the Service Department.
<b>Anti-crease Chk detergent flashes in the display.</b>	Excessive foam has built up during washing.	Use less detergent next time and follow the manufacturer's instructions on dosage given on the packaging.

① To switch off the fault message: Switch the machine off with *I-On/0-Off* button.

## Problem solving guide

<b>General problems</b>		
<b>Problem</b>	<b>Possible cause</b>	<b>Remedy</b>
<b>The machine shakes during the spin cycle.</b>	The machine feet are not level.	Level the machine (see "Installation").
<b>The laundry has not been spun properly and is still wet.</b>	The machine detected an imbalance during the final spin and reduced the spin speed automatically.	Include both large and small items in the load as this will give better distribution.
<b>The laundry has not spun satisfactorily.</b>	The spin speed selected was too low.	Select a higher spin speed next time.
<b>The pump makes strange noises.</b>	This is not a fault! These noises occur at the end of a pump sequence as a normal part of the operation.	
<b>There is a lot of detergent residue in the detergent drawer.</b>	The water pressure is too low.	<ul style="list-style-type: none"> <li>– Clean the water inlet filter.</li> <li>– Select Water plus.</li> </ul>
	Powder detergent used with water softeners can be sticky.	Add washing powder and then add the water softener.
<b>Fabric conditioner is not completely dispensed or too much water remains in the ☼ compartment.</b>	The siphon tube is not correctly positioned or is clogged up.	Clean the siphon, (see "Cleaning and care - Cleaning the detergent dispenser drawer").
<b>The display is in a different language.</b>	A different language has been selected in the Programmable functions - Language 🚩 menu.	Set the language you want. The flag symbol will guide you.
<b>When laundry is dry, it feels hard to the touch.</b>	Too vigorous wash action.	Programme in gentle action and more water.
	Not enough detergent used.	Increase detergent dose to prevent limescale build-up in laundry.
	No fabric conditioner used	Use fabric conditioner in last rinse.

## Problem solving guide

An unsatisfactory wash result		
Problem	Possible cause	Remedy
<b>Liquid detergent does not give the required result.</b>	Liquid detergents usually contain no bleaching agents. They do not remove fruit, coffee and tea stains.	<ul style="list-style-type: none"> <li>– Use a general purpose detergent containing a bleaching agent.</li> <li>– Pour stain removers into compartment  of the dispenser drawer and liquid detergent into a dispenser ball.</li> <li>– Never put stain removers and liquid detergent together in the dispenser drawer.</li> </ul>
<b>Grey, greasy particles cling to washed laundry.</b>	Insufficient amounts of detergent were used to break down the particles of grease in heavily soiled laundry.	<ul style="list-style-type: none"> <li>– Use more detergent.</li> <li>– Before washing the next load run a <i>Cottons 95°C</i> programme with powder detergent but without a load.</li> </ul>
<b>A stale smell is in the drum and on laundry.</b>	Low temperature washing.	<ul style="list-style-type: none"> <li>– Before washing the next load run a <i>Cottons 95°C</i> programme with powder detergent but without a load.</li> </ul>
<b>White residues which look like powder detergent are seen on dark textiles after washing.</b>	The detergent contained compounds (zeolites) to aid water softening which are not soluble in water. They have ended up on the laundry.	<ul style="list-style-type: none"> <li>– Try and brush off the residues with a soft brush once the laundry is dry.</li> <li>– Wash dark textiles using a detergent which contains no zeolites. Liquid detergents usually contain no zeolites.</li> <li>– Use the <i>Dark garments</i> programme.</li> </ul>
<b>Clothes are coming out creased.</b>	Programme was overloaded.	<ul style="list-style-type: none"> <li>– Reduce quantity of clothes in drum.</li> </ul>
	The wrong programme was used.	<ul style="list-style-type: none"> <li>– Check care labels and the programme chart.</li> <li>– Use easy iron conditioners.</li> </ul>

<b>The drum door does not open when you press the Door button</b>	
<b>Possible cause</b>	<b>Remedy</b>
<b>The machine is not connected to the electricity supply and/or is not switched on.</b>	Insert the plug in the socket and switch on and/or switch the machine on with the <i>I-On/O-Off</i> button.
<b>The safety lock has been activated.</b>	Deactivate the safety lock as described in "Changing the programme sequence - Safety lock".
<b>Access via a code has been activated.</b>	Deactivate the code as described in "Programmable functions - Code".
<b>Power cut.</b>	Open the drum door as described in the next section.
<b>The door was not correctly engaged.</b>	Press hard against the lock side of the drum door and then press the <i>Door</i> button.
<b>There is still water in the drum and the machine is unable to drain.</b>	Clean the drain filter and drain pump as described in the next section.
For safety reasons the drum door cannot be opened if the suds temperature is higher than 55°C.	

## Problem solving guide

### Opening the drum door in the event of a blocked drain outlet and/or power failure

- Switch the washing machine off.

There is a lever behind the detergent drawer fascia panel.

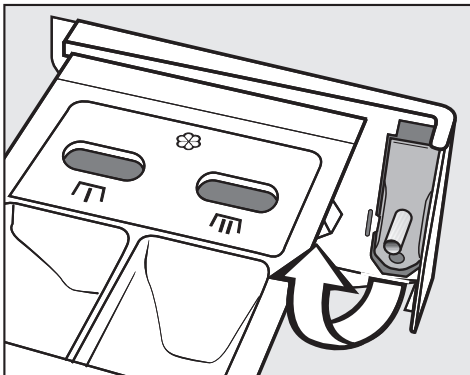

- Remove the lever.

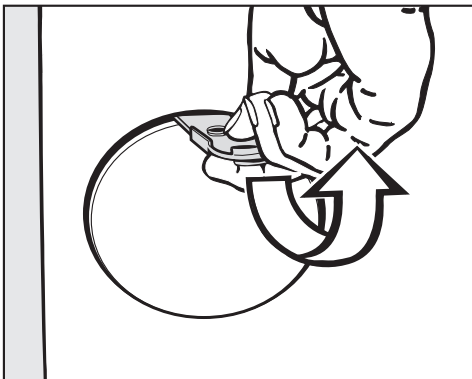

- Use it to open the access flap.

### Blocked drain outlet

If the drain outlet is blocked, up to 25 litres of water will be retained in the machine.

⚠ Caution: if laundry has been washed at a high temperature, water draining out of the machine will still be hot. Danger of scalding!

### Procedure for draining the machine

- Place a suitable container under the access flap.

When draining water from the machine, do **not** unscrew the drain filter completely or take it right out.

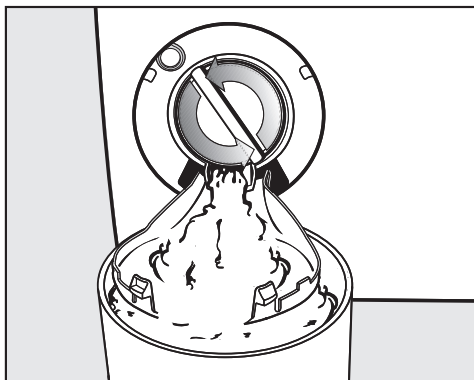

- Unscrew the drain filter lid until water runs out.

To interrupt the flow of water:

- Tighten the drain filter back up again.



## Problem solving guide

Once the flow of water ceases:

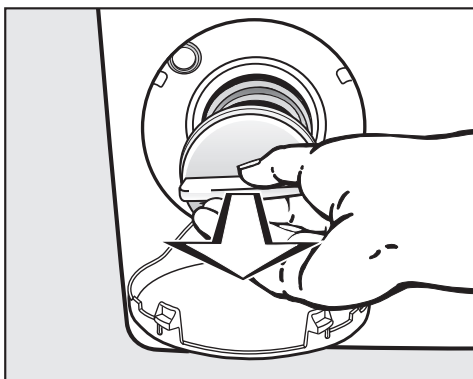

- Remove the drain filter completely.
- Clean it thoroughly.

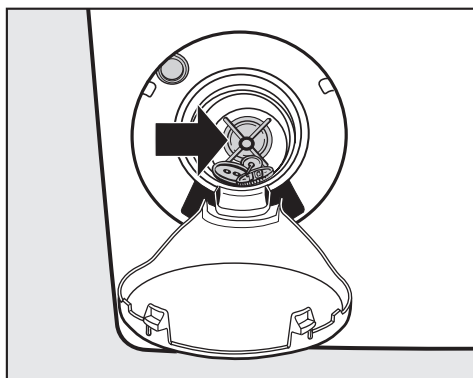

- Remove any foreign objects (e.g. buttons, coins, etc.) and fluff from the filter housing. Turn the impeller by hand to check that it rotates freely. Any foreign object causing an obstruction should be removed.
- Put the drain filter back in place and secure.

 Make sure the drain filter is securely tightened. Otherwise there is a risk of water leakage during use.

### Opening the drum door

 Always make sure that the drum is stationary before reaching into the machine to remove laundry. Reaching into a moving drum is extremely dangerous.

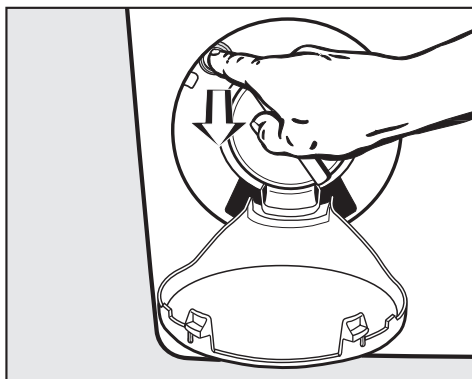

- Pull the emergency release downwards (see illustration). The drum door will open.

## After sales service

---

In the event of any faults which you cannot remedy yourself, please contact:

- your Miele Dealer or
- the Miele Customer Contact Centre (see back cover for contact details).

When contacting your Dealer or Miele, please quote the model and serial number of your machine, both of which are shown on the data plate visible above the porthole glass when the door is open.

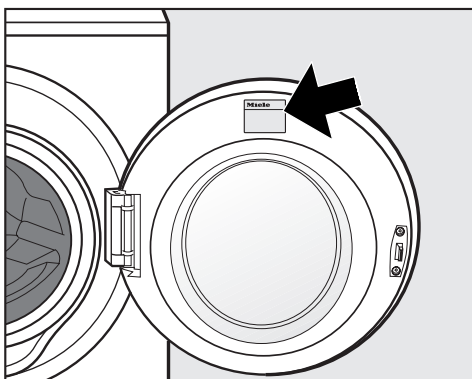

### Future updates (PC)

The indicator light marked PC is the interface used by Miele service technicians during servicing work for testing purposes and for updating the machine's programme data.

### Appliance guarantee

Please see the guarantee card supplied with your machine.

### Optional accessories

Optional accessories for this washing machine are available from your Miele Dealer, the Miele Spare Parts Department or via the internet at [www.miele-shop.com](http://www.miele-shop.com).

Please note that telephone calls may be monitored and recorded for training purposes.

# Installation and connection

## Front view

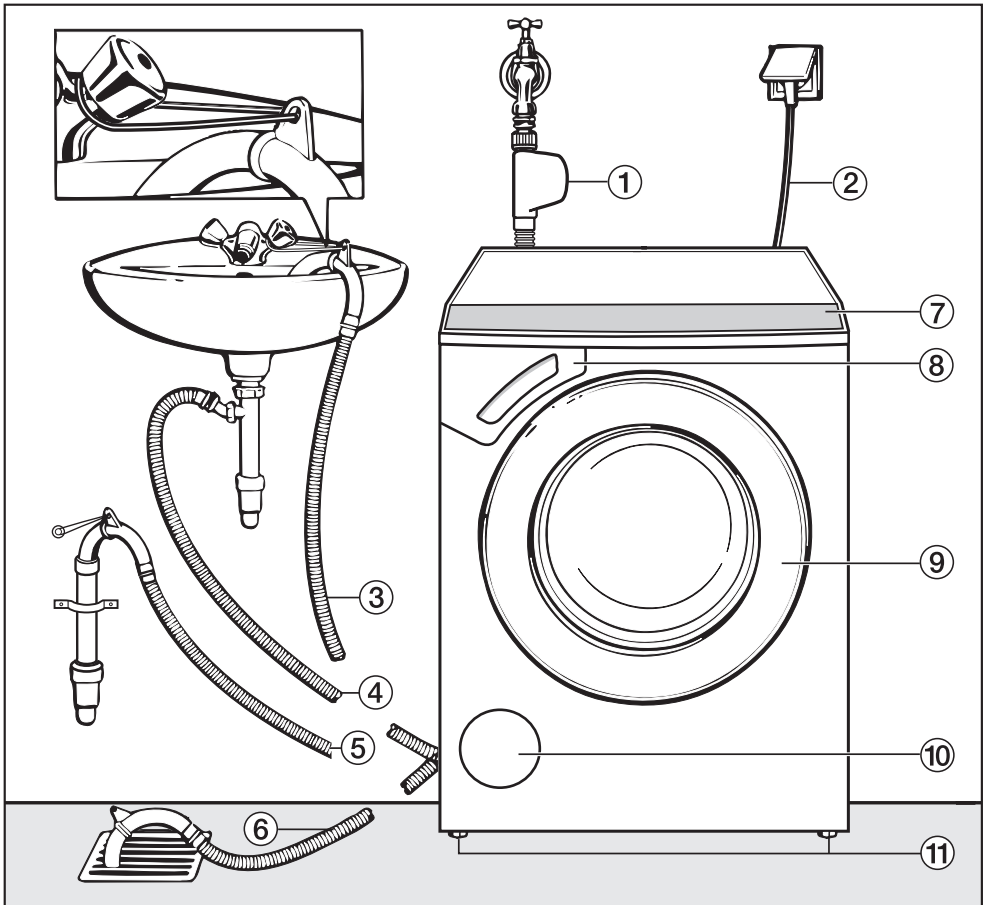

① Inlet hose with "Waterproof" system

② Electricity supply cable

③ - ⑥ Flexible drain hose (with detachable swivel elbow)

⑦ Control panel

⑧ Detergent dispenser drawer

⑨ Drum door

⑩ Access to drain filter, drain pump and emergency release

⑪ Four height adjustable feet

# Installation and connection

## Rear view

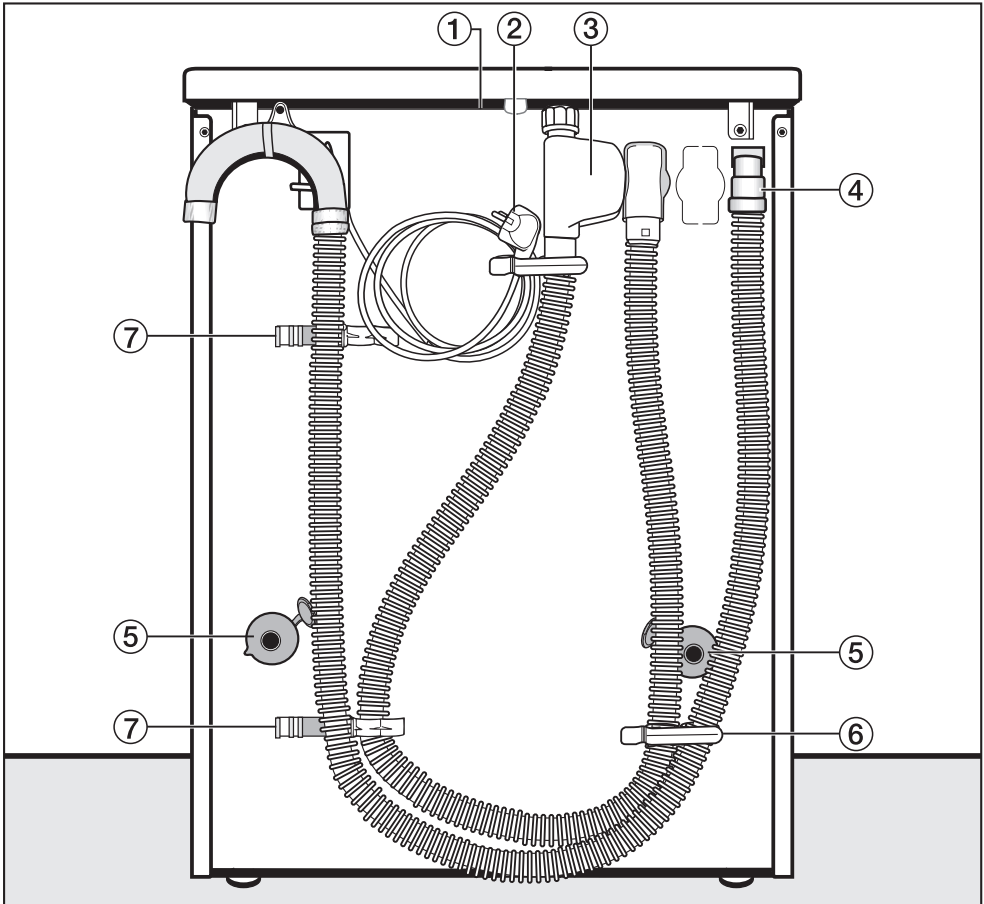

- ① Protruding lid for holding when moving the machine
- ② Electricity supply cable
- ③ Inlet hose with "Waterproof" system
- ④ Drain hose

- ⑤ Transit bar covers
- ⑥ Restraining clip for inlet hose and drain hose
- ⑦ Restraining clips for transit bars when removed

# Installation and connection

## Installation surface

A concrete floor is the most suitable installation surface for a washing machine, being far less prone to vibration during the spin cycle than wooden floorboards or a carpeted surface.

Please note the following points:

- The machine must be level and securely positioned.
- To avoid vibrations during spinning, the machine should not be installed on soft floor coverings.

If installing on a wooden joist floor:

- We recommend a plywood base (at least 59x52x3 cm). The base should span several joists and be bolted to the joists and not only to the floorboards. Check for the presence of pipes and cables first.

If possible, install the machine in a corner, as this is usually the most stable part of the floor.

⚠ If the machine is installed on a raised plinth, it **has to be secured** against slippage during spinning using retaining clips (available from the Miele Spare Parts Dept).

## Transporting the machine to its installation site

To manoeuvre the machine out of its packing case to its installation site, hold it by the front feet as well as by the edge of the lid where it protrudes to the rear of the washing machine.

⚠ Ensure that the machine feet and the floor are dry to prevent the machine from slipping during the spin cycle.

## Removing the transit fittings

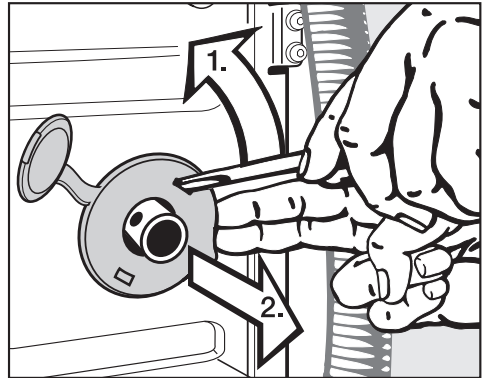

- To remove the left and right covers
  1. Use a screwdriver to prise out the cover as illustrated.
  2. Pull the cover forwards to remove.

## Installation and connection

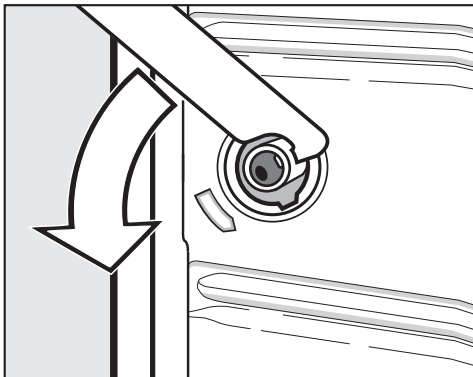

- Using the spanner supplied, turn the left-hand transit bar 90°, then

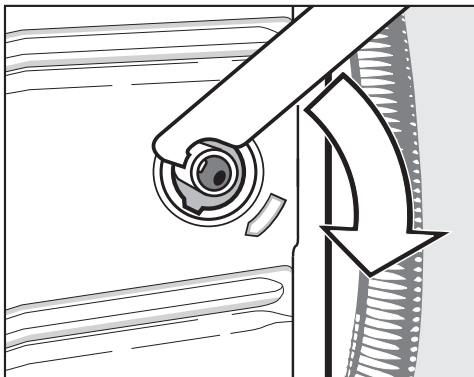

- Turn the right-hand transit bar 90°, then

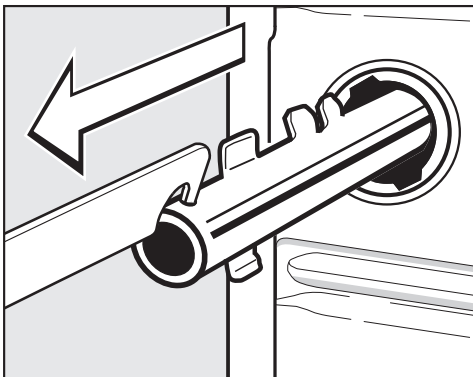

- withdraw the transit bar.

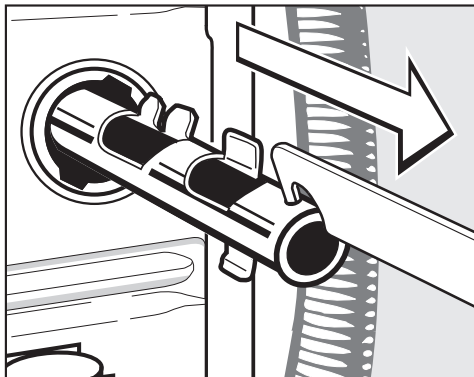

- withdraw the transit bar.

## Installation and connection

 To avoid the risk of injury the holes for the transit bars must be covered after the transit bars have been removed.

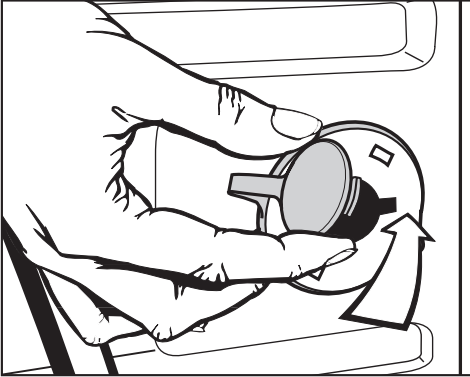

- Fit the covers onto the two holes. Then plug the holes as shown with the caps.

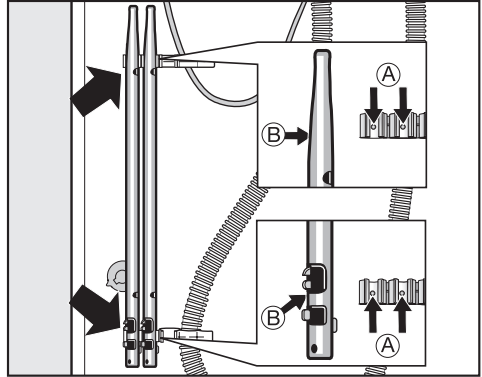

- Secure the transit bars to the back of the washing machine. Make sure that holes **B** are fitted over retainers **A**.

 The machine must not be moved without the transit bars in place. Store them as shown or keep them in a safe place for future use. They must be re-fitted if the machine is to be moved again (e.g. when moving house).

### Re-fitting the transit bars

Re-fitting is carried out by reversing the procedure.

# Installation and connection

## Levelling the machine

The machine must stand perfectly level on all four feet to ensure safe and proper operation.

Incorrect installation may increase electricity and water consumption and may cause the machine to move about.

## Screwing out and adjusting the feet

The four adjustable screw feet are used to level the machine. All four feet are screwed in when the machine is delivered.

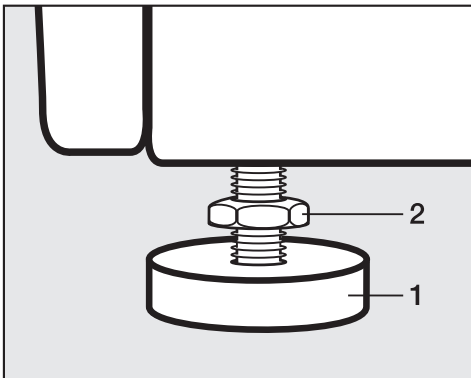

- Using the spanner supplied, turn counter nut **2** in a clockwise direction. Then turn counter nut **2** together with foot **1** to unscrew.

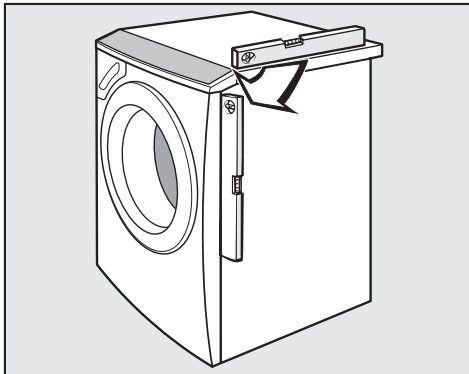

- Use a spirit level to check the machine is standing level.
- Hold foot **1** securely with a pipe wrench. Turn counter nut **2** again using the spanner supplied until it sits firmly up against the housing.

 All four counter nuts must sit firmly up against the housing. Please also check this for the feet which did not need adjustment. Otherwise there is the danger of the machine moving about.

This washing machine is not suitable for building under a worktop.



## Washer-dryer stack

A T 200, T 4000, T 7000 or T 8000 Miele tumble dryer can be stacked on this machine using a WTV stacking kit which can be purchased from your Dealer or the Miele Spare Parts Department.

## Washer-dryer stack using a T 7000 series dryer and WTV 417 stacking kit

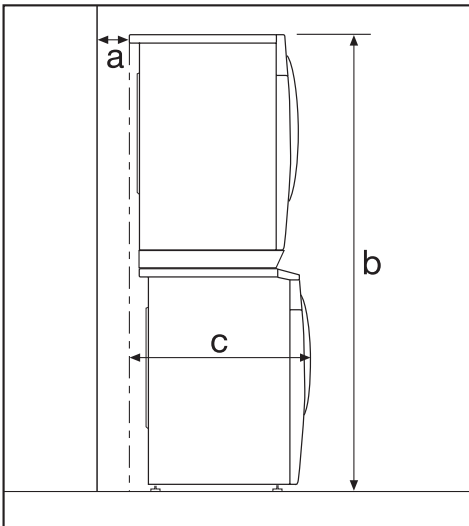

- a** Safety distance to wall:  
at least 2 cm
- b** Height:  
approx. 179 cm
- c** Depth of the washer-dryer stack:  
approx. 67.5 cm

## Washer-dryer stack using a T 200, T 4000 or T 8000 series dryer and WTV 412 stacking kit

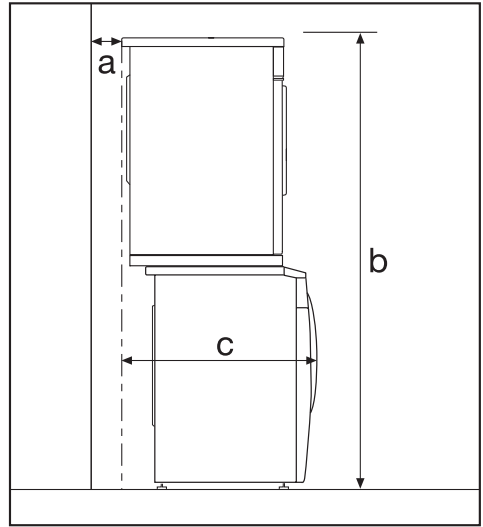

- a** Safety distance to wall:  
at least 2 cm
- b** Height:  
approx. 170 cm
- c** Depth of the washer-dryer stack:  
approx. 69.5 cm

# Installation and connection

---

## The Miele Waterproof system

The Miele Waterproof system protects the washing machine from water damage.

The system consists of three main components:

- 1) the inlet hose
- 2) the electronic unit and the washing machine housing
- 3) the drain hose

### 1) Inlet hose

- The inlet hose is fitted with an additional electrical safety valve which works like an automatic stopcock and is housed in the inlet hose connection box.
- It is pressure tested to between 7,000 and 10,000 kPa.
- The inlet hose has a protective sleeve.

Any leaking water from the inlet hose is fed into the sump through this protective sleeve. A float switches off the safety valve, preventing any more water from flowing into the machine and water in the suds container is pumped away.

### 2) Electronic unit and washing machine housing

- Sump

Any leaking water is collected in a sump in the base of the machine. A float switches off the safety valves, preventing any more water from flowing into the machine and water in the suds container is pumped away.

- Overflow protection

This prevents the washing machine taking in too much water. If the water level exceeds a certain level, the drain pump switches in and pumps the excess water away.

### 3) Drain hose

The drain hose is protected by a ventilation system which prevents the washing machine from being emptied completely.

## Connection to the water supply

 The plastic casing of the safety valve contains electrical components. The Waterproof system must only be connected to its own stopcock. It must not be connected to mixer taps or similar and must not be fitted in areas where there is the risk of water or other liquids reaching it.

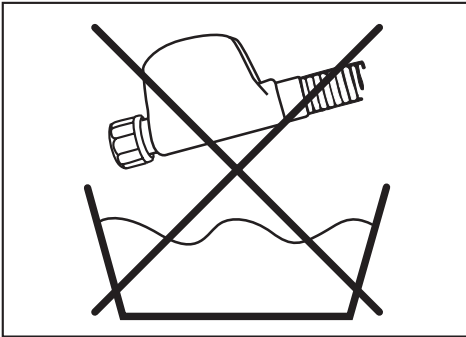

**Do not get wet.**

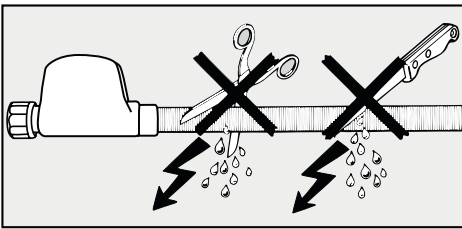

**The protective sleeve of the hose must not be damaged or kinked.**

The machine should be connected to the mains water supply in accordance with local and national safety regulations. The German authorities do not require it to have a non-return valve as the washing machine has been designed to comply with DIN regulations.

The machine is designed to operate with a flow pressure of between 100 and 1,000 kPa (1-10 bar). If it is higher than 1,000 kPa it is essential to fit a pressure reducing valve.

Connection to the mains water supply should incorporate a mains stopcock with  $\frac{3}{4}$ " thread. The stopcock should be fitted by a qualified plumber.

 The connection point is subject to mains water pressure. Turn on the stopcock slowly and check for leaks. Correct the position of the washer and union if appropriate.

The washing machine is **not** suitable for connection to a hot water supply and connection to a household water softener is not recommended.

# Installation and connection

---

## Maintenance and care

If you intend to unscrew the Miele Waterproof system hose from the stopcock it is essential to disconnect the machine from the electricity supply first.

Only use a **Miele Waterproof system** hose should you need a replacement.

In order to protect the water inlet valve, the dirt filter in the water inlet valve connection must not be removed.

## Extension hose

A 1.5 metre long (metal) extension hose is available from your Miele dealer or the Miele Spare Parts Department as an optional extra.

This hose is tested to withstand pressures of up to 14,000 kPa and can be used as a flexible extension to the water supply.

N.B. Using this hose renders the Waterproof system safety valve on the inlet hose ineffective.

## Connection to the drainage system

The machine drains via a drain pump with a delivery head of 1 metre\*. The drain hose must not be kinked as this restricts drainage. The swivel elbow at the end of the hose can be turned in either direction, or can be detached if required, with a sharp twist and pull.

If required, the drain hose can be extended to a length of 5 m. The necessary parts can be purchased from the Miele Spare Parts Department or your Miele dealer.

\* For a delivery head of more than 1 m (up to a max. of 1.8 m) a replacement drain pump will need to be fitted. Please contact the Miele Spare Parts Department or your Miele Dealer.

### Drain hose connection:

1. Direct into a sink or basin:

Please note the following:

- Hook the hose over the edge and secure.
  - Make sure that the water can drain away freely without hindrance. Otherwise there is a risk of water overflowing or of some of the drained water being sucked back into the machine.
2. Connected securely to a plastic drain pipe with a rubber nipple. There is no need to use a non-return valve.
  3. Connected securely to a standpipe.
  4. Connected securely to a floor gully.

Please note:

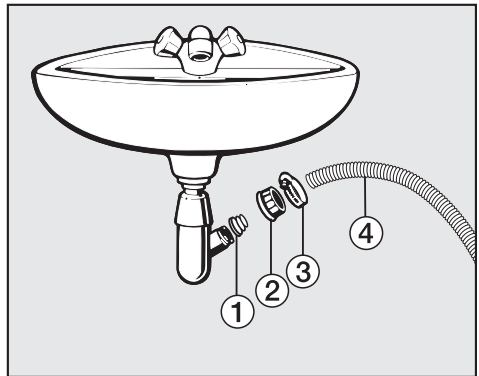

① Adapter

② Nut

③ Hose clip

④ End of the hose

- Fit adapter ① to the sink drain outlet using nut ②.
- Attach the end of the hose ④ to adapter ①.
- Use a screwdriver to tighten hose clip ③ up close to the nut.

# Installation and connection

---

## Electrical connection U.K.

All electrical work should be carried out by a suitably qualified and competent person, in strict accordance with current national and local safety regulations (BS 7671 in the UK).

Ensure power is not supplied to the appliance until after installation work has been carried out.

The appliance is supplied with a mains cable with moulded plug ready for connection to a 230-240V mains supply.

Please ensure the connection data quoted on the data plate match the household mains supply.

Connection should be made via a suitable switched socket which is easily accessible after installation.

For extra safety it is advisable to install a suitable residual current device (RCD). Contact a qualified electrician for advice.

Do not connect via an extension lead. Extension leads do not guarantee the required safety of the appliance (e.g. danger of overheating).

## Non-rewireable plugs BS 1363

The fuse cover must be refitted when changing the fuse, and if the fuse cover is lost, the plug must not be used until a suitable replacement is obtained. The colour of the correct replacement cover is that of the coloured insert in the base of the plug, or the colour that is embossed in words on the base of the plug (as applicable to the design of plug fitted).

Replacement fuses should be ASTA approved to BS 1362 and have the correct rating. Replacement fuses and fuse covers may be purchased from your local electrical supplier.

## **WARNING: THIS APPLIANCE MUST BE EARTHED**

# Consumption data

		Load	Consumption data			
			Energy in kWh	Water in litres	Duration	
					Short	Normal
<b>Cottons</b>	95°C	6.0 kg	1.99	47		2 h 09 min
	60°C <sup>1)</sup>	6.0 kg	1.02	47		1 h 49 min
	60°C	3.0 kg	0.73	39	1 h 02 min	
	40°C <sup>1)</sup>	6.0 kg	0.65	59		2 h 04 min
	40°C <sup>2)</sup>	3.0 kg	0.36	39	59 min	
<b>Minimum iron</b>	40°C <sup>1)</sup>	3.0 kg	0.50	55	59 min	1 h 19 min
<b>Delicates</b>	30°C	2.0 kg	0.35	69	49 min	59 min
<b>Woolens</b> 🧶	30°C	2.0 kg	0.23	39	–	39 min
<b>Silks</b> 🧵	30°C	1.0 kg	0.25	39	–	36 min
<b>Express</b>	40°C	3.0 kg	0.30	34	–	30 min
<b>Automatic</b>	40°C	3.5 kg	0.35 - 0.50	40 - 55	–	1 h 18 min
<b>Shirts</b>	60°C	2.0 kg	1.00	59	1 h 02 min	1 h 12 min
<b>Denim</b>	40°C	3.0 kg	0.50	52	50 min	1 h 00 min
<b>Outerwear</b>	40°C	2.0 kg	0.45	59	53 min	1 h 03 min
<b>Dark garments</b>	40°C	3.0 kg	0.60	60	1 h 05 min	1 h 15 min

## Notes for test institutes:

- 1) EN 60456 test programme
- 2) Short programme for test institutes; the *Short* extra option must be selected.

Consumption data can vary from the nominal values given depending on water pressure, water hardness, water inlet temperature, room temperature, type and volume of load, fluctuations in the electricity supply and any extra options selected.

## Technical data

---

Height	850 mm
Width	595 mm
Depth	634 mm
Depth with door open	1074 mm
Weight	99 kg
Maximum floor load	1,600 Newton (approx. 160 kg)
Capacity	6 kg dry laundry
Voltage	see data plate
Connected load	see data plate
Fuse rating	see data plate / plug
Consumption data	see "Consumption data"
Water flow pressure minimum	100 kPa (1 bar)
Water flow pressure maximum	1,000 kPa (10 bar)
Inlet hose length	1.60 m
Drain hose length	1.50 m
Mains connection cable length	1.60 m
Delivery head max.	1.00 m
Maximum drainage length	5.00 m
LEDs	Class 1
Test certificates awarded	see data plate



## Programmable functions for changing default settings

The programmable functions are used to alter the machine's electronics to suit changing requirements.  
Programmable functions can be altered at any time.

# Programmable functions

## To access programmable functions

The programmable functions are accessed via the *Start/Stop* button and the programme selector.

Before you begin, first ensure that:

- The washing machine is switched off.
- The machine is properly closed.

① Press the *Start/Stop* button and keep it pressed in whilst carrying out steps ②-③.

② Press the *I-On/O-Off* button in.

③ As soon as . . .

Language 🚩...

. . . appears in the display, release the *Start/Stop* button.

## To select a programmable function

- ④ Turn the programme selector until the programmable function you require appears in the display.
- ⑤ Press the *Start/Stop* button to confirm your selection.

## To alter a programmable function

You can see the different options available for a programmable function by turning the programme selector.

The option which is currently set will have a tick ✓ beside it.

⑥ Turn the programme selector until the option you want appears in the display.

⑦ Press the *Start/Stop* button to activate this option.

## To come out of programmable functions

⑧ Turn the programme selector until *Back* ⬅️ appears in the display.

⑨ Press the *Start/Stop* button.

## Language 🚩

The display can be set to appear in one of several different languages.

The flag 🚩 after the word *Language* acts as a guide to prevent a language which will not be understood from being set.

The language selected is saved to memory.

## Water plus

This programmable function is used to select the water intake setting for the *Water plus* extra option.

There are three different options:

### Water +

(the machine is delivered with this option selected)

The water level is increased in the wash and rinse stages.

### Extra rinse

An extra rinse is introduced.

### Water+ & Extra rinse

The water intake is increased in the wash and rinse stages and an additional rinse is also introduced.

## Gentle action

Activating gentle action reduces the drum action and is suitable for washing slightly soiled items more gently. It should be activated for garments with a single bar under the care label and for articles which feel too hard after they have been dried.

Gentle action can be activated for the *Cottons* and the *Minimum iron* programmes.

The washing machine is delivered with the Gentle action setting deactivated.

## Suds cooling

When this is activated, additional water flows into the drum at the end of the main wash to cool the suds down. Hot suds can damage plastic drainage pipes.

Suds cooling takes place when temperatures of 95°C and 75°C are selected.

Suds cooling should be activated:

- to prevent the danger of scalding if the drain hose is hooked over the edge of a sink or basin.
- where the drainage pipes do not comply with DIN 1986.

The machine is delivered with Suds cooling deactivated.

# Programmable functions

## Code

A code can be used to lock the electronics on the washing machine to prevent it being used without your knowledge.

When the code has been activated, you have to enter a code after switching the washing machine on. Otherwise the washing machine cannot be operated.

Code ...

- Press the *Start/Stop* button.

### To activate the code

Activate

- Press the *Start/Stop* button.

The display will now request that a code is entered.

### To enter the code

The code is **125** and cannot be altered.

0 \_ \_

- Turn the programme selector until the first number appears in the display.
- Confirm your selection of the number by pressing the *Start/Stop* button.
- Repeat the process until all three numbers have been entered.

1 2 5

- Press the *Start/Stop* button.

The following will appear in the display:

Code activated

Once the machine is switched off, it can only be used again if the code is entered.

### To use the washing machine when the code is activated

When the machine is switched on again, the display will request the code.

- Enter code 125 as described above and confirm the entry.

The washing machine is now unlocked and ready for use.

### To deactivate the code

Make sure the washing machine is switched off and the door is properly closed. Press the *Start/Stop* button and keep it pressed in whilst you press the *I-On/O-Off* button in.

As soon as . . .

0 \_ \_

. . . appears in the display, release the *Start/Stop* button.

- Now enter the code and press the *Start/Stop* button.
- Select *Code* and confirm *Deactivate*.

# Programmable functions

---

## Temperature unit

You can choose for the temperature to be displayed as °C/*Celsius* or °F/*Fahrenheit*.

The machine is delivered with °C/*Celsius* as the default setting.

## Buzzer

When the buzzer function has been activated, an audible tone sounds at the end of a programme or when Rinse hold is reached.

There are two volumes:

### Normal

(the machine is delivered with this option as the default setting.)

The buzzer sounds at the end of a programme or when Rinse hold is reached.

### Loud

The buzzer sounds at maximum volume *Loud* at the end of a programme or when Rinse hold is reached.

## Keypad tone

An audible tone sounds each time a button is pressed.

The machine is delivered with the keypad tone deactivated.

## Brightness

There are ten different display brightness settings.

The bar chart shows you the setting.

The machine is delivered with the display brightness on setting 5.

This will change as soon as a different setting is chosen.

## Contrast

There are ten different display contrast settings.

The bar chart shows you the setting.

The machine is delivered with the display contrast on setting 5.

This will change as soon as a different setting is chosen.

# Programmable functions

---

## Standby display

To save energy, the display goes out and the indicator light for the *Start/Stop* button will start flashing slowly.

The display will always go out,

- if a programme is not selected within 10 minutes of the machine being switched on.
- 10 minutes after the end of a programme.

Pressing one of the buttons switches the display back on again.

You can also choose whether you want the display to go out 10 minutes after a programme has started or to remain visible throughout the programme.

### On

The standby function is switched on. When this option is selected, the display will go out 10 minutes after a programme has started.

### Not in current prog.

(the machine is delivered with this option selected)

The standby function is switched off. The display will remain visible during a programme.

## Memory

The washing machine will store the most recently selected settings (programme, temperature, spin speed and any extra options) in memory once the programme has started.

These settings will appear in the display the next time the machine is switched on.

The machine is delivered with the memory function deactivated.

## Anti-crease

Anti-crease helps prevent creasing if laundry is not normally removed immediately after the end of a programme.

The drum will turn at intervals for up to 30 minutes after the programme has finished.

The door can be opened and laundry removed at any time during the anti-crease phase.

### On

(the machine is delivered with this option selected)

Anti-crease is activated.

### Off

Anti-crease is deactivated.

Miele washing machines offer perfect care for your laundry and feature a wide range of special programmes designed to suit the fabric being washed. And now Miele have developed a range of specialist CareCollection detergents and conditioning products to offer you a complete package for cleaning and caring for your laundry.

The Miele CareCollection detergents and conditioning products are listed below. You can order these and many other useful products via the internet at:



All the products can also be ordered via the Miele Customer Contact Centre (see back cover for contact details).

## CareCollection

### Miele specialist detergents

#### "Outdoor wear"

This specialist detergent will clean your water-repellent outerwear with care.

#### "Sportswear"

The Miele Sportswear detergent is designed to clean sportswear whilst taking care of the special microfibres used in these garments. It will help to neutralise and remove odours whilst protecting the colour of the fabric and preventing static build-up.

#### "Down Items"

This special-purpose detergent contains a mild tenside and has been specially formulated to keep down-filled items supple and to give them bounce.

### Miele proofing agent

This special finishing agent reproofs garments against wind and water and provides a dirt-repellent finish whilst retaining elasticity and breathability.

## Optional accessories

---

### **"UltraWhite" detergent**

This multi-purpose powder detergent has excellent stain removal properties and is suitable for white and light coloured laundry as well as heavily soiled coloured items.

### **"UltraColor" detergent for coloured garments**

This liquid detergent is particularly suitable for cleaning coloured and dark garments. The special formulation offers effective stain removal, even at low temperatures, while helping to prevent colours fading.

### **Liquid detergent "For Delicates"**

This liquid detergent is ideal for the gentle treatment of delicate fabrics, such as wool and silk. Its special formulation cleans effectively at temperatures as low as 20°C, while protecting the colour of your delicate garments.

### **Fabric conditioner**

The Miele fabric conditioner will give your laundry a fresh, natural fragrance. It makes garments soft to handle and prevents static build-up during tumble drying.











## **United Kingdom**

Miele Co. Ltd.  
Fairacres, Marcham Road  
Abingdon, Oxon, OX14 1TW  
Tel: (01235) 554455  
Fax: (01235) 554477  
Customer Contact Centre Tel: (08707) 554466  
E-mail: [info@miele.co.uk](mailto:info@miele.co.uk)  
Internet: [www.miele.co.uk](http://www.miele.co.uk)

## **Australia**

Miele Australia Pty. Ltd.  
ABN 96 005 635 398  
1 Gilbert Park Drive, Knoxfield, VIC 3180  
Tel: (03) 9764 7130  
Fax: (03) 9764 7149  
Internet: [www.miele.com.au](http://www.miele.com.au)

## **China**

Miele Shanghai  
Suite 4105-06, Plaza 66  
1266 Nanjing Road West  
Jing An District  
Shanghai 200040, PRC  
Tel: +86 21 6288 4200  
Fax: +86 21 6288 4100  
E-mail: [mieleshanghai@cn.miele.com](mailto:mieleshanghai@cn.miele.com)  
Internet: [www.miele.cn](http://www.miele.cn)

## **Hong Kong**

Miele (Hong Kong) Limited  
AIA Plaza, 24<sup>th</sup> Floor  
18 Hysan Avenue  
Causeway Bay  
Tel: +852- 2610-1331  
Fax: +852-2610-1013  
E-mail: [mielehk@miele.com.hk](mailto:mielehk@miele.com.hk)  
Internet: [www.miele.hk](http://www.miele.hk)

## **Ireland**

Miele Ireland Ltd.  
Broomhill Road, Tallaght, Dublin 24  
Tel: (01) 461 0710  
Fax: (01) 461 07 97  
E-Mail: [info@miele.ie](mailto:info@miele.ie)  
Internet: [www.miele.ie](http://www.miele.ie)

## **New Zealand**

Miele New Zealand Limited  
Unit L, 10-20 Sylvia Park Road  
Mt. Wellington, 1060, Auckland, NZ  
Tel: 0800 264 353  
Fax: 0800 463 453  
Internet: [www.miele.co.nz](http://www.miele.co.nz)

## **South Africa**

Miele (Pty) Ltd  
63 Peter Place, Bryanston 2194  
P.O. Box 69434, Bryanston 2021  
Tel: +27 (0) 11 548-1900  
Fax: +27 (0) 11 548-1935  
E-mail: [info@miele.co.za](mailto:info@miele.co.za)  
Internet: [www.miele.co.za](http://www.miele.co.za)

## **Singapore**

Miele Southeast Asia  
Miele Pte. Ltd.  
163 Penang Road  
# 04 - 02/03 Winsland House II  
Singapore 238463  
Tel: +65 6735 1191  
Fax: +65 6735 1161  
E-Mail: [infosea@miele.com.sg](mailto:infosea@miele.com.sg)  
Internet: [www.miele.sg](http://www.miele.sg)

## **United Arab Emirates**

Miele Appliances Ltd.  
P.O. Box 11 47 82  
Gold & Diamond Park  
Sheikh Zayed Road  
Building 6 / Offices Nos. 6-214 to 6-220  
Dubai  
Tel: +971-4-341 84 44  
Fax: +971-4-341 88 52  
E-Mail: [info@miele.ae](mailto:info@miele.ae)  
Internet: [www.miele.ae](http://www.miele.ae)